

agent

simplycommunicate



agent 1000

Instruction Manual

INTRODUCTION

Thank you for purchasing the Agent 1000. This product meets all the CE standards of approval for the UK. Please read this user guide before use.

FEATURES

- 10 one-touch memories
- Music on hold
- Last number redial function
- Pause
- Ringing volume Low/High
- Headset volume Low/Medium/High
- In use LED indicator
- Hands-free dialing and speaking
- Dedicated headset port

SAFETY INSTRUCTIONS

1. Unplug the line cord before cleaning. Use a soft damp cloth for cleaning.
2. Do not place this product on unstable surfaces.
3. Never push foreign objects of any kind into this product.

EMERGENCY CALLS

Calls can be made on this telephone to contact the emergency services.

The European code for emergency services is 112. However, you can still use 999 in the UK.

An access code may also be required if the phone is connected to a PABX.

BUTTONS & FEATURES

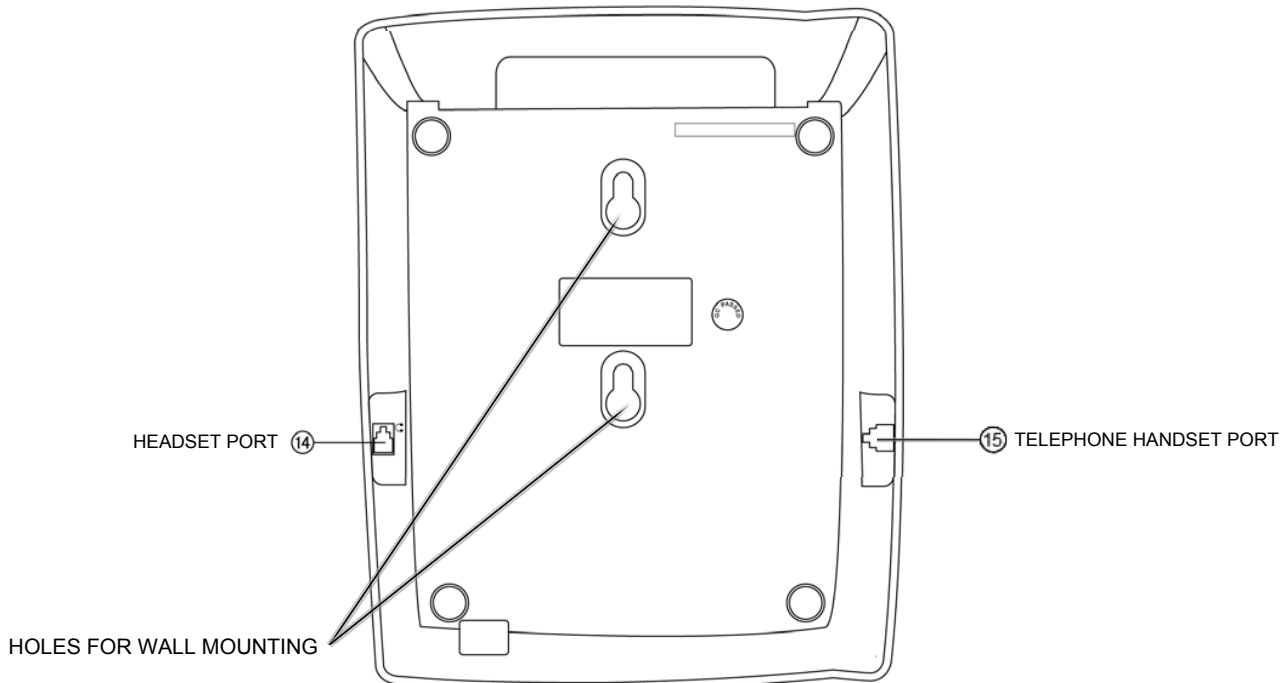
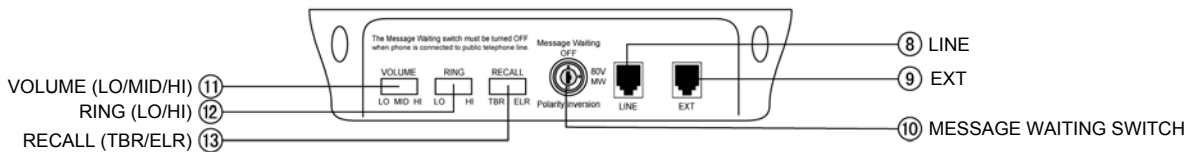
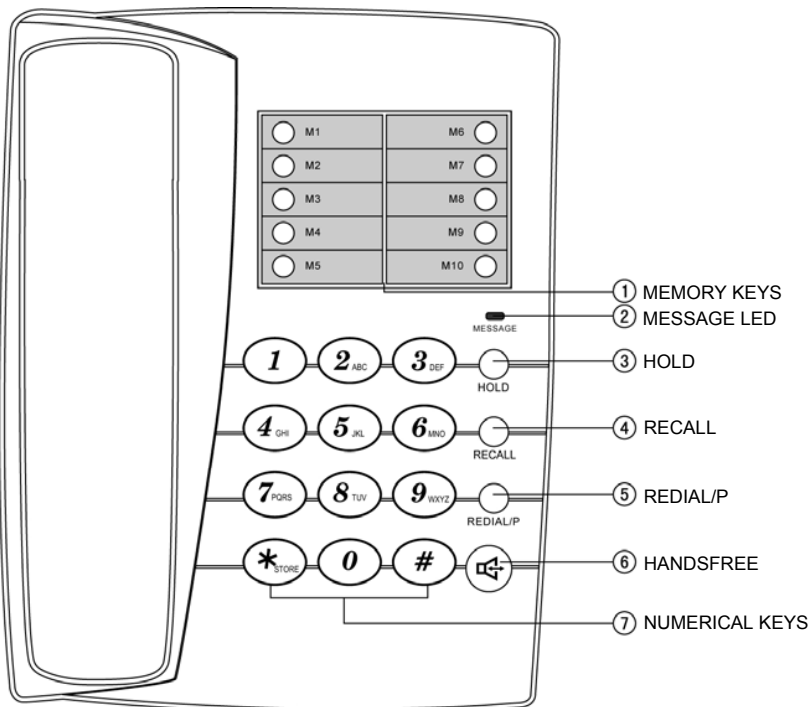

WALL MOUNTING

Position the telephone where you want to fix it to the wall. Drill two holes and fix roundheaded screws, leaving them slightly proud of the surface. Position the telephone over the screws and slide downwards into place.

INSTALLATION



1. Insert one end of the line cord into the line jack of the phone (8) and connect the other end to your BT socket.
2. Connect the handset cord to the telephone handset port (15).
3. Select the desired volume for calls (11) and your telephone ringer (12).

RECEIVING A CALL



➤ From the handset

1. Pick up the handset to commence your call.
2. When finished, return the handset to the base to end the call.

➤ Switching to speakerphone

1. When using the handset, press  key (6) and return the handset to the base.
2. When finished, press  key (6) to end the call.

➤ From the speakerphone



1. When the telephone rings, press  key (6) to talk to the caller. For the other party to hear your voice clearly, speak into the speaker from a distance of 32cm or less.
2. When finished, press  key (6) to end the call.

MAKING A CALL

➤ From the handset

1. Pick up the handset.
2. When you hear the dial tone, dial the desired number.
3. When finished, return the handset to the base to end the call.

➤ From Speakerphone



1. Press  key (6)
2. When you hear the dial tone, dial the desired number.
3. When finished, press  key (6) again.

➤ Redial

1. Pick up the handset or press  key (6).
2. Press **REDIAL/P** key (5), the last dialled number will be dialled again

USING A HEADSET

Insert the jack plug on your headset cable into the headset port (14). Your headset is now ready to use.

- To answer an incoming call, press  (6).
- To end the call, press  (6).

ONE TOUCH MEMORY OPERATION

➤ To store a number in one-touch memory

1. Pick up the handset or press  key (6), then press and hold the ***_{STORE}** key for 3 seconds.
2. Dial the phone number you want to store.
3. Press one of the memory keys (1) to store the phone number under the corresponding memory number

➤ To make a call from one-touch memory

Pick up the handset or press  key (6), then press the newly programmed memory key to dial the desired number.

FLASH FUNCTION

The **RECALL/FLASH** time on the Agent 1000 is set to 100ms.

PAUSE

When dialling, press **REDIAL/P** key (5) to insert a 3.6s pause time between dialled numbers.

RECALL SWITCH

Before you attempt to change the recall switch (13), you should disconnect the phone from the network.

ADJUSTING HEADSET AND SPEAKERPHONE VOLUME

Slide the **VOLUME** switch to **LO**(Low) or **MID**(Middle) or **HI**(High) to adjust the headset or speakerphone volume.

ADJUSTING RINGING VOLUME

Slide the **RING** switch (12) to **HI**(High) or **LO**(Low) to select desired ringing volume.

MESSAGE WAITING LED INDICATOR

When used behind a PABX, this telephone will respond to voice messaging systems on many PABX types, giving a visual signal of a message waiting. Your telephone manager will be aware of which system is relevant to your organisation and will advise you on the adjustment of your telephone accordingly.

This adjustment is carried out by means of the message waiting switch (10).

TROUBLE SHOOTING

If your telephone does not appear to be working correctly, please check the following:

No dialling tone - Is phone cord connected to the wall socket?

Will not ring - REN number may exceed 4, for all telephones connected to the line.

Disconnect a phone until the number is below 4.

If you are still experiencing problems, please contact your Agent supplier.

NOTE:

Due to continuous product development, all features and specifications are subject to change without prior notice.